

Technický list

Výrobek: Pákové směšovací baterie

Kód: CBEE101, CBEE10101, CBEE10103, CBEE201, CBEE20101, CBEE20103, CBEE20104, CBEE350, CBEE501, CBEE301, CBEE301A, CBEE30101, CBEE301A01, CBEE30106, CBEE301A06, CBEE302, CBEE30201, CBEE30202, CBEE302A, CBEE302A01, CBEE302A02, CBEE60203, CBEE602A03, CBEE60103, CBEE601A03, CBEE60204, CBEE602A04, CBEE90103, CBEE901A03

Distributor: MSO Trade a.s.

Použití: Pákové mísící baterie nástěnné a stojánkové slouží ke směšování vody v systémech pro užitkovou i pitnou vodu. Pracovní teplota 0° C až 80° C.

Materiál jednotlivých dílů:

Tělo: mosaz chromovaná

Páka: mosaz chromovaná

Kartuš: keramická 35mm

Obrázek:





Technické výkresy:

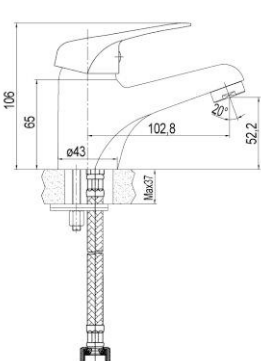

CBEE 101
CBEE 10101

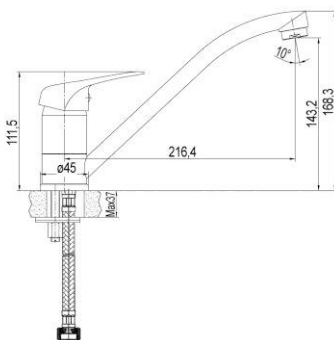

CBEE 201

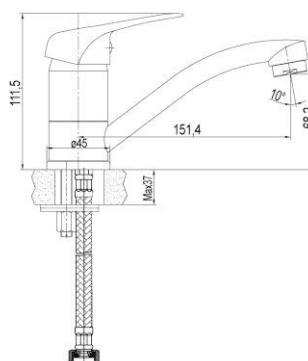

CBEE 20101

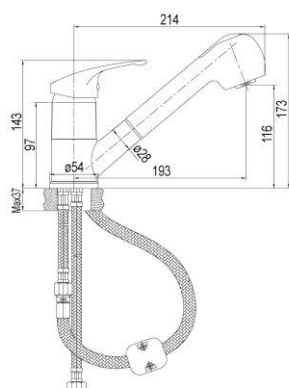

CBEE 350

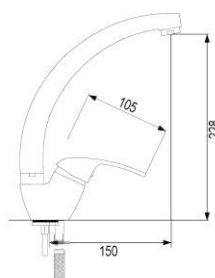

CBEE 20103

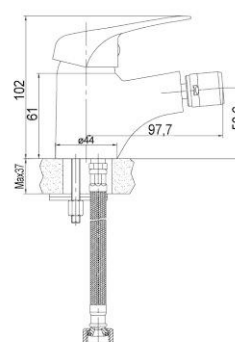

CBEE 501

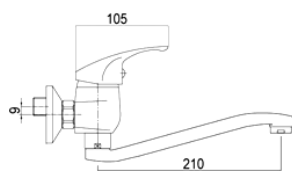
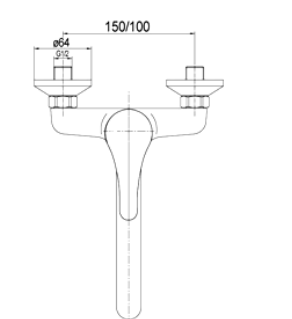

CBEE 301
CBEE 301A

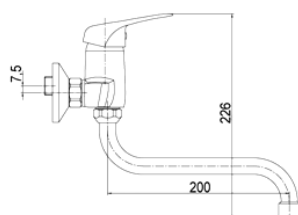
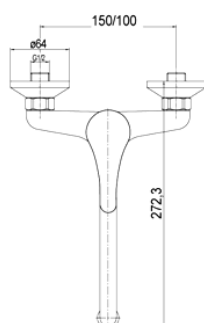

CBEE 30101
CBEE 301A01

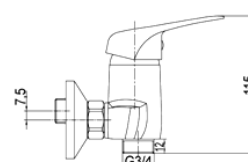
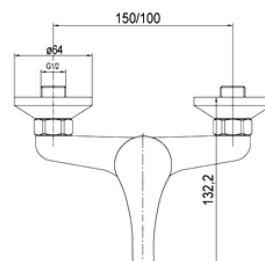

CBEE 30103
CBEE 301A03

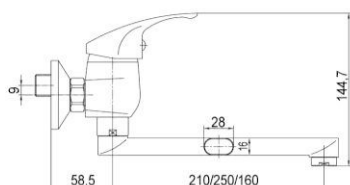
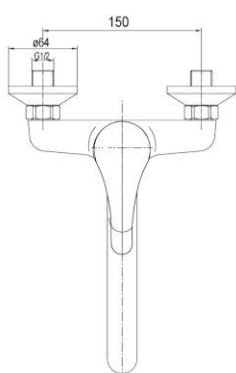

CBEE 302
CBEE 30201
CBEE 30202

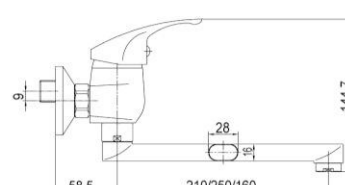
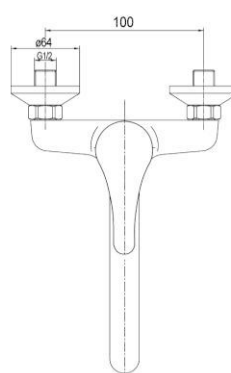

CBEE 302A
CBEE 302A01
CBEE 302A02

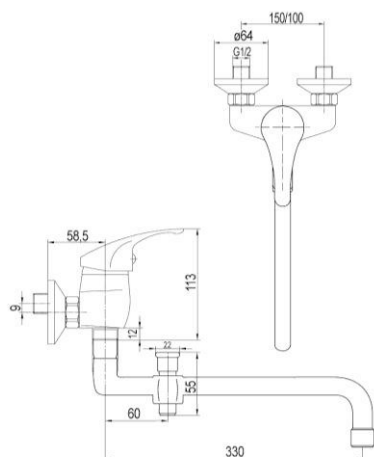

CBEE 60203
CBEE 602A03

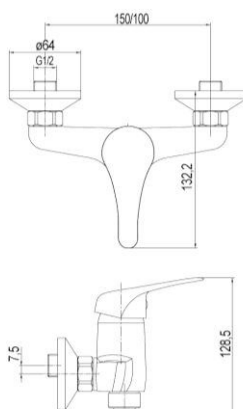

CBEE 60103
CBEE 601A03

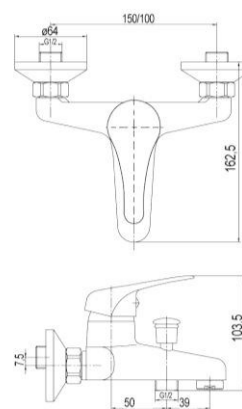

CBEE 90103
CBEE 901A03

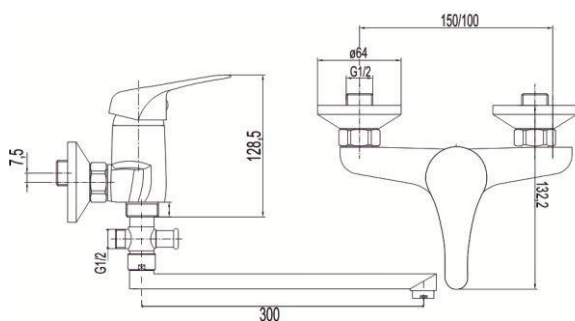

CBEE60204
CBEE602A04

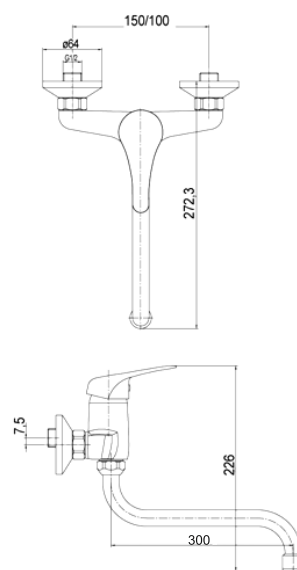

CBEE30106
CBEE301A06

Upozornění: Pro těsnění závitů doporučujeme použít pouze tyto těsnící materiály: teflonová páska, těsnící vlákno typu LOCTITE nebo těsnící tmel. Ostatní těsnící materiály nejsou pro tento typ výrobků přípustné.